

DATA SHEET

PCD3349A

**8-bit microcontroller with
DTMF generator**

Product specification
Supersedes data of 1996 Dec 18
File under Integrated Circuits, IC03

1998 May 11

8-bit microcontroller with DTMF generator**PCD3349A**

CONTENTS

1	FEATURES
2	GENERAL DESCRIPTION
3	ORDERING INFORMATION
4	BLOCK DIAGRAM
5	PINNING INFORMATION
5.1	Pinning
5.2	Pin description
6	FREQUENCY GENERATOR
6.1	Frequency generator derivative registers
6.2	Frequency registers
6.3	DTMF frequencies
6.4	Modem frequencies
6.5	Musical scale frequencies
7	TIMING
8	RESET
9	STOP MODE
10	IDLE MODE
11	INSTRUCTION SET
12	SUMMARY OF MASK OPTIONS
13	LIMITING VALUES
14	HANDLING
15	DC CHARACTERISTICS
16	AC CHARACTERISTICS
17	PACKAGE OUTLINES
18	SOLDERING
18.1	Introduction
18.2	DIP
18.3	SO
19	DEFINITIONS
20	LIFE SUPPORT APPLICATIONS

8-bit microcontroller with DTMF generator

PCD3349A

1 FEATURES

- 8-bit CPU, ROM, RAM, I/O in a single 28-lead package
- 4-kbyte ROM
- 224-byte RAM
- Over 100 instructions (based on MAB8048) all of 1 or 2 cycles
- 20 quasi-bidirectional I/O port lines
- 8-bit programmable Timer/event counter 1
- 2 single-level vectored interrupts:
 - external
 - Timer/event counter 1
- Two test inputs, one of which also serves as the external interrupt input
- DTMF tone generator
- Reference for supply and temperature-independent TONE output
- Filtering for low output distortion (CEPT compatible)
- Power-on-reset
- Stop and Idle modes
- Supply voltage: 1.8 to 6 V (DTMF TONE output from 2.5 V)
- Low standby voltage of 1 V
- Low Stop mode current of 1 μ A (typical)
- Clock frequency: 1 to 16 MHz (3.58 MHz for DTMF suggested)
- Manufactured in silicon gate CMOS process.

2 GENERAL DESCRIPTION

The PCD3349A provides 4 kbytes of Program Memory, 224 bytes of RAM and 20 I/O lines.

The PCD3349A is a microcontroller which has been designed primarily for telecom applications. It includes an on-chip dual tone multi-frequency (DTMF) generator.

The instruction set is based on that of the MAB8048 and is software compatible with the PCD33xxA family.

This data sheet details the specific properties of the PCD3349A. The shared characteristics of the PCD33xxA family of microcontrollers are described in the "PCD33xxA Family" data sheet and also in "Data Handbook IC03; Section PCD33xxA Family", which should be read in conjunction with this publication.

3 ORDERING INFORMATION

TYPE NUMBER	PACKAGE		
	NAME	DESCRIPTION	VERSION
PCD3349AP	DIP28	plastic dual in-line package; 28 leads (600 mil)	SOT117-1
PCD3349AT	SO28	plastic small outline package; 28 leads; body width 7.5 mm	SOT136-1

8-bit microcontroller with DTMF generator

PCD3349A

4 BLOCK DIAGRAM

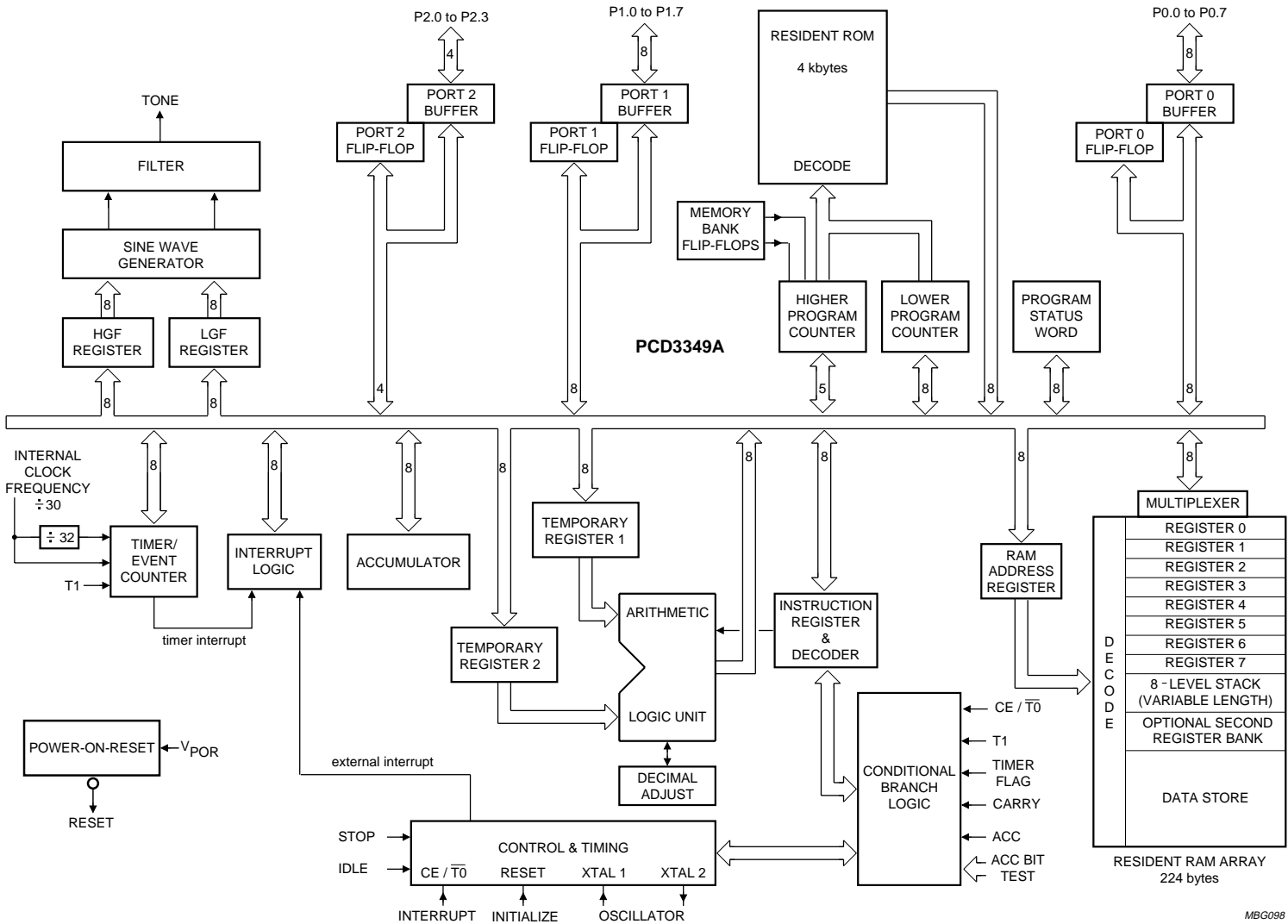

MBG098

Fig.1 Block diagram.

8-bit microcontroller with DTMF generator

PCD3349A

5 PINNING INFORMATION

5.1 Pinning

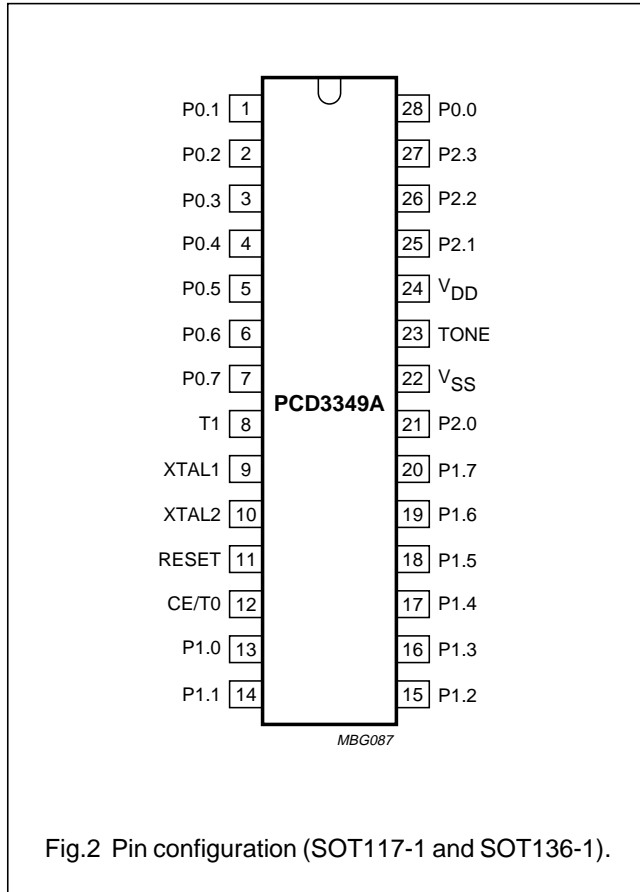

Fig.2 Pin configuration (SOT117-1 and SOT136-1).

5.2 Pin description

Table 1 SOT117-1 and SOT136-1 packages

SYMBOL	PIN	DESCRIPTION
P0.0 to P0.7	28, 1 to 7	Port 0: 8 quasi-bidirectional I/O lines
T1	8	Test 1 or count input of 8-bit Timer/event counter 1
XTAL1	9	crystal oscillator or external clock input
XTAL2	10	crystal oscillator output
RESET	11	reset input
CE/ $\overline{T0}$	12	Chip Enable or Test 0
P1.0 to P1.7	13 to 20	Port 1: 8 quasi-bidirectional I/O lines
P2.0 to P2.3	21, 25, 26, 27	Port 2: 4 quasi-bidirectional I/O lines
V _{SS}	22	ground
TONE	23	DTMF output
V _{DD}	24	positive supply voltage

8-bit microcontroller with DTMF generator

PCD3349A

6 FREQUENCY GENERATOR

A versatile frequency generator section is provided (see Fig.3). For normal operation, use a 3.58 MHz quartz crystal or PXE resonator. The frequency generator includes precision circuitry for dual tone multifrequency (DTMF) signals, which is typically used for tone dialling telephone sets.

The TONE output can alternatively issue twelve modem frequencies for data rates between 300 and 1200 bits/s.

In addition to DTMF and modem frequencies, two octaves of musical scale in steps of semitones are available.

6.1 Frequency generator derivative registers

Table 2 gives the derivative addresses, mnemonics and access types of the frequency generator derivative registers. The addresses 03H to FFH are not used.

Table 2 Addresses of the frequency generator derivative registers

ADDRESS	REGISTER	7	6	5	4	3	2	1	0
01H	HGF ⁽¹⁾	H7	H6	H5	H4	H3	H2	H1	H0
02H	LGF ⁽²⁾	L7	L6	L5	L4	L3	L2	L1	L0

Notes

- 1. HGF = High Group Frequency; access type W.
- 2. LGF = Low Group Frequency; access type W.

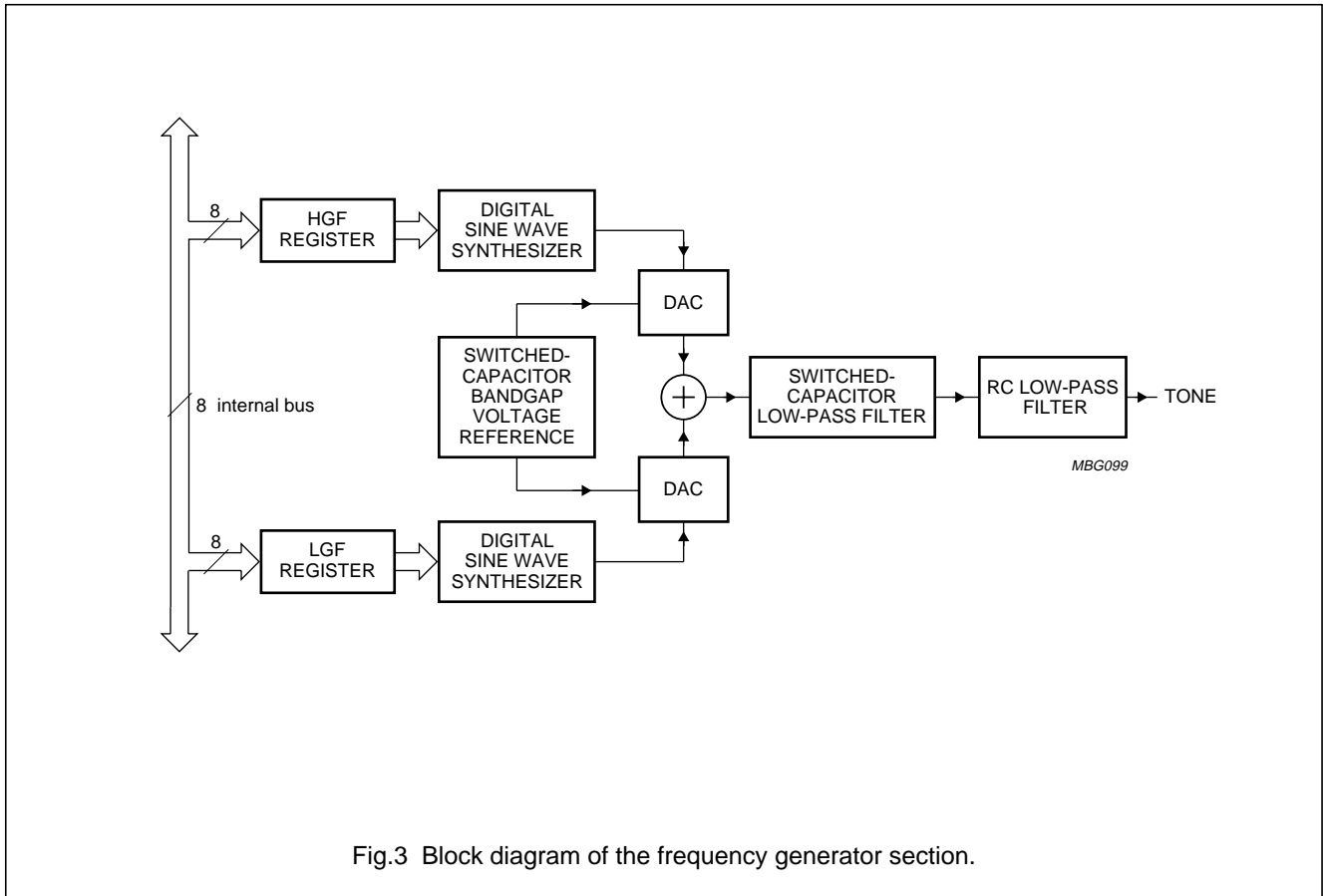

Fig.3 Block diagram of the frequency generator section.

8-bit microcontroller with DTMF generator

PCD3349A

6.2 Frequency registers

The two frequency registers HGF and LGF define two frequencies. From these, the digital sine synthesizers together with the Digital-to-Analog Converters (DACs) construct two sine waves. Their amplitudes are precisely scaled according to the bandgap voltage reference. This ensures TONE output levels independent of supply voltage and temperature. The amplitude of the Low Group Frequency sine wave is attenuated by 2 dB compared to the amplitude of the High Group Frequency sine wave.

The two sine waves are summed and then filtered by an on-chip switched capacitor and RC low-pass filters. These guarantee that all DTMF tones generated fulfil the CEPT recommendations with respect to amplitude, frequency deviation, total harmonic distortion and suppression of unwanted frequency components.

The value 00H in a frequency register stops the corresponding digital sine synthesizer. If both frequency registers contain 00H, the whole frequency generator is shut off, resulting in lower power consumption.

The frequency of the sine wave generated is dependent upon the decimal value 'x' held in the frequency registers (HGF and LGF), and this may be calculated as follows:

$$f = \frac{f_{xtal}}{[23(x+2)]}; \text{ where } 60 \leq x \leq 255.$$

The frequency limitation given by $x \geq 60$ is due to the low-pass filters which would attenuate higher frequency sine waves.

6.3 DTMF frequencies

Assuming an oscillator frequency $f_{xtal} = 3.58$ MHz, the DTMF standard frequencies can be implemented as shown in Table 3.

The relationship between telephone keyboard symbols and the frequency register contents are given in Table 4.

Table 3 DTMF standard frequencies and their implementation; value = LGF, HGF contents

VALUE (HEX)	FREQUENCY (Hz)		DEVIATION	
	STANDARD	GENERATED	(%)	(Hz)
DD	697	697.90	0.13	0.90
C8	770	770.46	0.06	0.46
B5	852	850.45	-0.18	-1.55
A3	941	943.23	0.24	2.23
7F	1209	1206.45	-0.21	-2.55
72	1336	1341.66	0.42	5.66
67	1477	1482.21	0.35	5.21
5D	1633	1638.24	0.32	5.24

Table 4 Dialling symbols, corresponding DTMF frequency pairs and frequency registers content

TELEPHONE KEYBOARD SYMBOLS	DTMF FREQ. PAIRS (Hz)	LGF VALUE (HEX)	HGF VALUE (HEX)
0	(941, 1336)	A3	72
1	(697, 1209)	DD	7F
2	(697, 1336)	DD	72
3	(697, 1477)	DD	67
4	(770, 1209)	C8	7F
5	(770, 1336)	C8	72
6	(770, 1477)	C8	67
7	(852, 1209)	B5	7F
8	(852, 1336)	B5	72
9	(852, 1477)	B5	67
A	(697, 1633)	DD	5D
B	(770, 1633)	C8	5D
C	(852, 1633)	B5	5D
D	(941, 1633)	A3	5D
•	(941, 1209)	A3	7F
#	(941, 1477)	A3	67

8-bit microcontroller with DTMF generator

PCD3349A

6.4 Modem frequencies

Again assuming an oscillator frequency $f_{\text{xtal}} = 3.58$ MHz, the standard modem frequency pairs summarized in Table 5 can be implemented. It is suggested to define the frequency by the HGF register while the LGF register contains 00H, disabling Low Group Frequency generation.

Table 5 Standard modem frequency pairs and their implementation

HGF VALUE (HEX)	FREQUENCY (Hz)		DEVIATION	
	MODEM	GENERATED	(%)	(Hz)
9D	980 ⁽¹⁾	978.82	-0.12	-1.18
82	1180 ⁽¹⁾	1179.03	-0.08	-0.97
8F	1070 ⁽²⁾	1073.33	0.31	3.33
79	1270 ⁽²⁾	1265.30	-0.37	-4.70
80	1200 ⁽³⁾	1197.17	-0.24	-2.83
45	2200 ⁽³⁾	2192.01	-0.36	-7.99
76	1300 ⁽⁴⁾	1296.94	-0.24	-3.06
48	2100 ⁽⁴⁾	2103.14	0.15	3.14
5C	1650 ⁽¹⁾	1655.66	0.34	5.66
52	1850 ⁽¹⁾	1852.77	0.15	2.77
4B	2025 ⁽²⁾	2021.20	-0.19	-3.80
44	2225 ⁽²⁾	2223.32	-0.08	-1.68

Notes

- Standard is V.21.
- Standard is Bell 103.
- Standard is Bell 202.
- Standard is V.23.

6.5 Musical scale frequencies

Finally, two octaves of musical scale in steps of semitones can be realized, again assuming an oscillator frequency $f_{\text{xtal}} = 3.58$ MHz (Table 6). It is suggested to define the frequency by the HGF register while the LGF contains 00H, disabling Low Group Frequency generation.

Table 6 Musical scale frequencies and their implementation

NOTE	HGF VALUE (HEX)	FREQUENCY (Hz)	
		STANDARD ⁽¹⁾	GENERATED
D#5	F8	622.3	622.5
E5	EA	659.3	659.5
F5	DD	698.5	697.9
F#5	D0	740.0	741.1
G5	C5	784.0	782.1
G#5	B9	830.6	832.3
A5	AF	880.0	879.3
A#5	A5	923.3	931.9
B5	9C	987.8	985.0
C6	93	1046.5	1044.5
C#6	8A	1108.7	1111.7
D6	82	1174.7	1179.0
D#6	7B	1244.5	1245.1
E6	74	1318.5	1318.9
F6	6D	1396.9	1402.1
F#6	67	1480.0	1482.2
G6	61	1568.0	1572.0
G#6	5C	1661.2	1655.7
A6	56	1760.0	1768.5
A#6	51	1864.7	1875.1
B6	4D	1975.5	1970.0
C7	48	2093.0	2103.3
C#7	44	2217.5	2223.3
D7	40	2349.3	2358.1
D#7	3D	2489.0	2470.4

Note

- Standard scale based on A4 at 440 Hz.

8-bit microcontroller with DTMF generator

PCD3349A

7 TIMING

Although the PCD3349A operates over a clock frequency range from 1 to 16 MHz, $f_{xtal} = 3.58$ MHz will usually be chosen to take full advantage of the frequency generator section.

8 RESET

In addition to the conditions given in the "PCD33xxA Family" data sheet, all derivative registers are cleared in the RESET state.

9 STOP MODE

Since the oscillator is switched off, the frequency generator receives no clock. It is suggested to clear both the HGF and LGF registers before entering Stop mode. This will cut-off the biasing of the internal amplifiers, considerably reducing current requirements.

10 IDLE MODE

In the Idle mode, the frequency generator remains operative.

11 INSTRUCTION SET RESTRICTIONS

Since no serial I/O interface is provided, the serial I/O (Input/Output) instructions are not available. 'MOV Dx, A' is the only applicable derivative instruction because the derivative registers are write-only.

ROM space being restricted to 4 kbytes, SEL MB2/3 would define non-existing Program Memory banks and should therefore be avoided.

RAM space being restricted to 224 bytes, care should be taken to avoid accesses to non-existing RAM locations.

12 SUMMARY OF MASK OPTIONS**Table 7** Port mask options

PORT NAME	PORT OUTPUT DRIVE ⁽¹⁾			PORT STATE AFTER RESET ⁽²⁾	
	OPTION 1	OPTION 2	OPTION 3	SET	RESET
Port 0 (P0.0 to P0.7)	X	X	X	X	X
Port 1 (P1.0 to P1.7)	X	X	X	X	X
Port 2 (P2.0 to P2.7)	X	X	X	X	X

Notes

- Port output drives:
 - Option 1: standard I/O.
 - Option 2: open-drain I/O.
 - Option 3: push-pull output; see "PCD33xxA Family" data sheet.
- Port state after reset: S = Set (HIGH) and R = Reset (LOW).

Table 8 Mask options

FEATURE	DESCRIPTION
ROM code: program/data	Any mix of instructions and data up to ROM size of 4 kbytes.
Power-on-reset voltage level: V_{POR}	1.2 to 3.6 V in increments of 100 mV; OFF
Oscillator transconductance: g_m	LOW transconductance: g_{mL}
	MEDIUM transconductance: g_{mM}
	HIGH transconductance: g_{mH}

8-bit microcontroller with DTMF generator

PCD3349A

13 LIMITING VALUES

In accordance with the Absolute Maximum Rating System (IEC 134); see note 1 and 2.

SYMBOL	PARAMETER	MIN.	MAX.	UNIT
V_{DD}	supply voltage	-0.5	+7.0	V
V_I	all input voltages	-0.5	$V_{DD} + 0.5$	V
I_I, I_O	DC input or output current	-10	+10	mA
P_{tot}	total power dissipation	-	125	mW
P_O	power dissipation per output	-	30	mW
I_{SS}	ground supply current	-50	+50	mA
T_{stg}	storage temperature	-65	+150	°C
T_j	operating junction temperature	-	90	°C

Notes

- Stresses above those listed under Limiting Values may cause permanent damage to the device.
- Parameters are valid over operating temperature range unless otherwise specified. All voltages are with respect to V_{SS} unless otherwise noted.

14 HANDLING

Inputs and outputs are protected against electrostatic discharge in normal handling. However, it is good practice to take normal precautions appropriate to handling MOS devices (see "Handling MOS devices").

15 DC CHARACTERISTICS

$V_{DD} = 1.8$ to 6 V; $V_{SS} = 0$ V; $T_{amb} = -25$ to $+70$ °C; all voltages with respect to V_{SS} ; $f_{xtal} = 3.58$ MHz (g_{mL}); unless otherwise specified.

SYMBOL	PARAMETER	CONDITIONS	MIN.	TYP.	MAX.	UNIT
Supply (see Figs 5 to 9)						
V_{DD}	supply voltage		1.8	-	6	V
	operating; note 1 RAM data retention in Stop mode		1.0	-	6	V
I_{DD}	operating supply current; note 2	$V_{DD} = 3$ V; value HGF $\neq 0$ and/or LGF $\neq 0$	-	0.9	1.8	mA
		$V_{DD} = 3$ V	-	0.3	0.6	mA
		$V_{DD} = 5$ V; $f_{xtal} = 10$ MHz (g_{mL})	-	1.1	3.0	mA
		$V_{DD} = 5$ V; $f_{xtal} = 16$ MHz (g_{mM})	-	1.7	5.0	mA
		$V_{DD} = 5$ V; $f_{xtal} = 16$ MHz (g_{mH})	-	2.5	6.0	mA
$I_{DD(idle)}$	supply current Idle mode; note 2	$V_{DD} = 3$ V; value HGF $\neq 0$ and/or LGF $\neq 0$	-	0.7	1.4	mA
		$V_{DD} = 3$ V; value HGF = LGF = 0	-	0.2	0.4	mA
		$V_{DD} = 5$ V; $f_{xtal} = 10$ MHz (g_{mL})	-	0.8	1.6	mA
		$V_{DD} = 5$ V; $f_{xtal} = 16$ MHz (g_{mM})	-	1.2	4.0	mA
		$V_{DD} = 5$ V; $f_{xtal} = 16$ MHz (g_{mH})	-	1.7	5.0	mA
$I_{DD(stp)}$	supply current Stop mode	$V_{DD} = 1.8$ V; $T_{amb} = 25$ °C; note 3	-	1.0	2.5	μ A
		$V_{DD} = 1.8$ V; $T_{amb} = 70$ °C; note 3	-	-	10	μ A

8-bit microcontroller with DTMF generator

PCD3349A

SYMBOL	PARAMETER	CONDITIONS	MIN.	TYP.	MAX.	UNIT
Inputs						
V_{IL}	LOW-level input voltage		0	–	$0.3V_{DD}$	V
V_{IH}	HIGH-level input voltage		$0.7V_{DD}$	–	V_{DD}	V
I_{IL}	input leakage current	$V_{SS} \leq V_I \leq V_{DD}$	–1	–	+1	μA
Port outputs (see Figs 10 to 12)						
I_{OL}	LOW-level port sink current	$V_{DD} = 3\text{ V}; V_O = 0.4\text{ V}$	0.7	3.5	–	mA
I_{OH}	HIGH-level port pull-up source current	$V_O = 2.7\text{ V}; V_{DD} = 3\text{ V}$	–10	–20	–	μA
		$V_O = 0\text{ V}; V_{DD} = 3\text{ V}$	–	–100	–300	μA
I_{OH}	HIGH-level port push-pull source current	$V_{DD} = 3\text{ V}; V_O = 2.6\text{ V}$	–0.7	–4	–	mA
TONE output (see Fig.4; notes 1 and 4)						
$V_{HG_{rms}}$	HGF voltage (RMS)		158	181	205	mV
$V_{LG_{rms}}$	LGF voltage (RMS)		125	142	160	mV
$\Delta f/f$	frequency deviation		–0.6	–	0.6	%
V_{DC}	DC voltage level		–	$0.5V_{DD}$	–	V
$ Z_O $	output impedance		–	100	500	Ω
V_G	pre-emphasis of group		1.5	2.0	2.5	dB
THD	total harmonic distortion	$T_{amb} = 25\text{ }^\circ\text{C}; \text{note 5}$	–	25	–	dB
Power-on-reset						
ΔV_{POR}	Power-on-reset level variation around chosen V_{POR}	note 6	–0.5	0	+0.5	V

Notes

1. TONE output requires $V_{DD} \geq 2.5\text{ V}$.
2. $V_{IL} = V_{SS}$; $V_{IH} = V_{DD}$; open-drain outputs connected to V_{SS} ; all other outputs open; value HGF = LGF = 0, unless otherwise specified.
3. Crystal connected between XTAL1 and XTAL2; pins T1 and $\overline{CE/T0}$ at V_{SS} ; value HGF = LGF = 0.
4. Values are specified for DTMF frequencies only (CEPT).
5. Related to the Low Group Frequency (LGF) component (CEPT).
6. V_{POR} is an option chosen by the user. Depending on its value, it may restrict the supply voltage range.

8-bit microcontroller with DTMF generator

PCD3349A

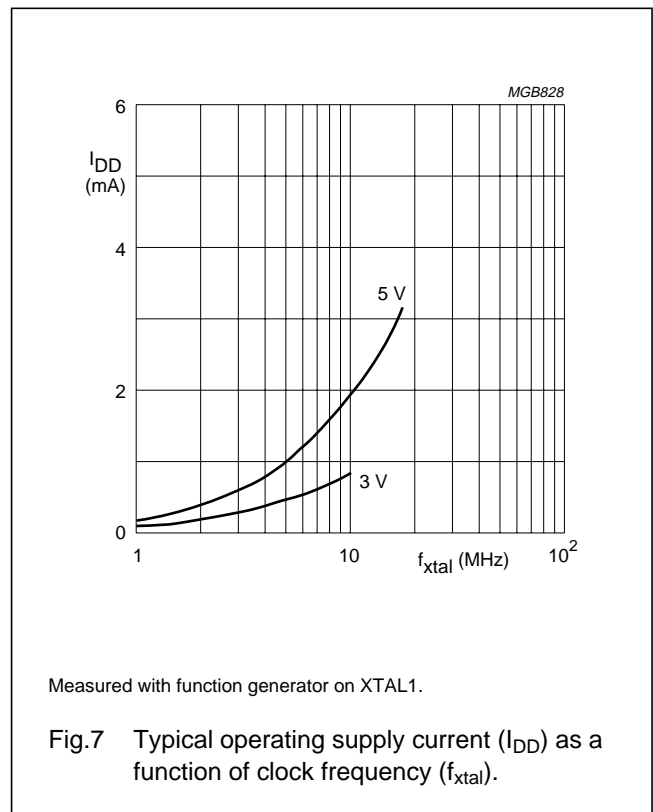
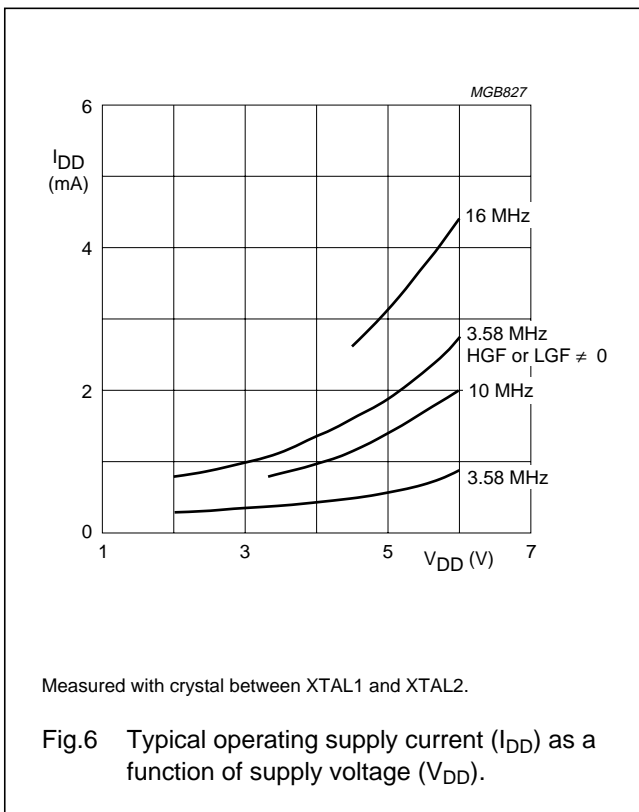
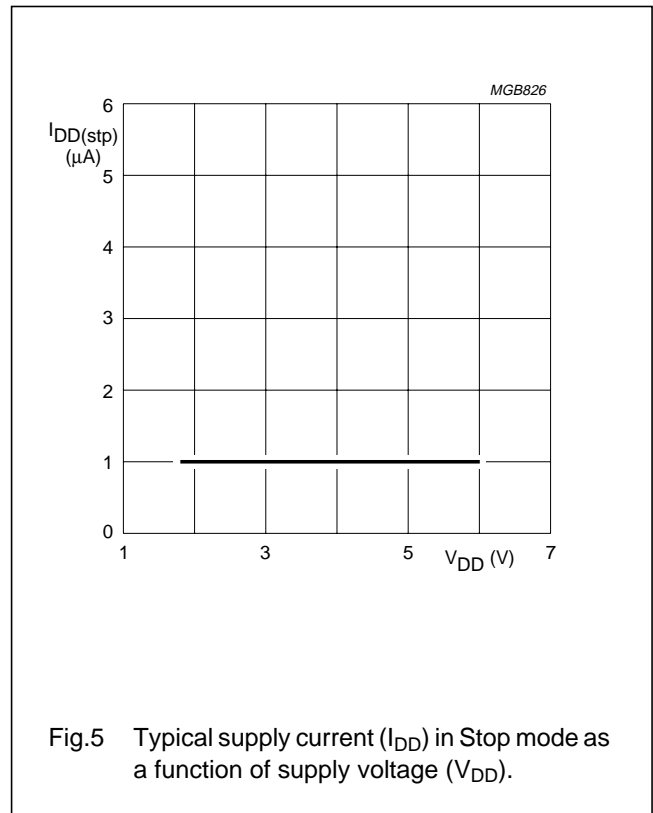
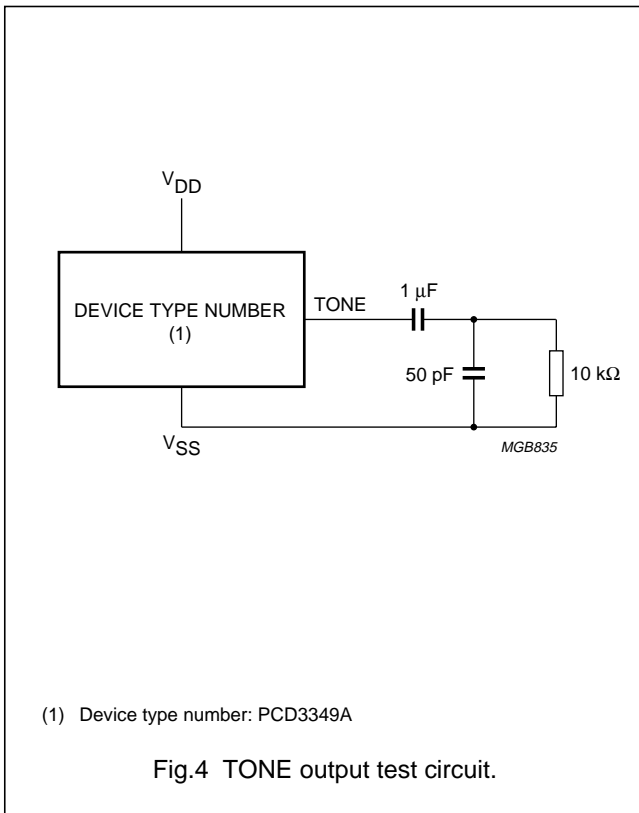

8-bit microcontroller with DTMF generator

PCD3349A

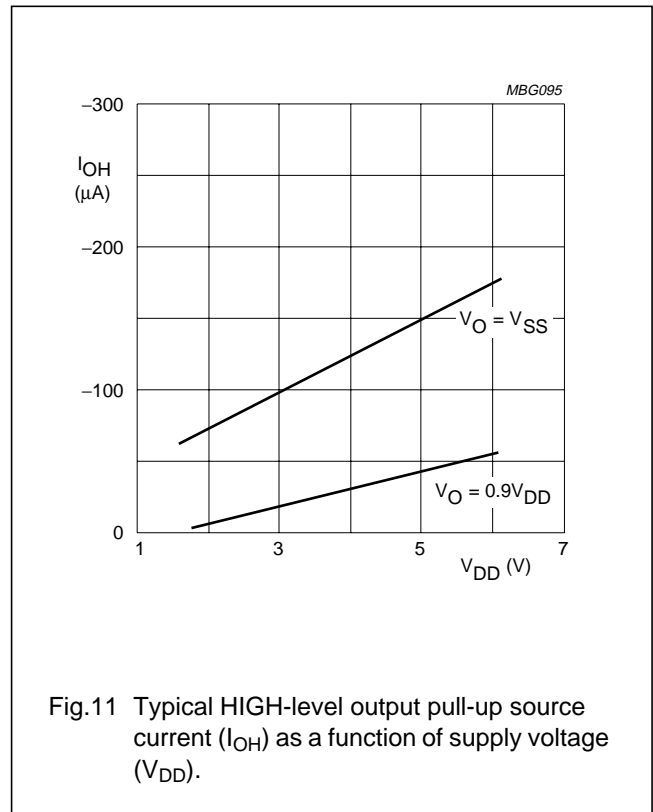
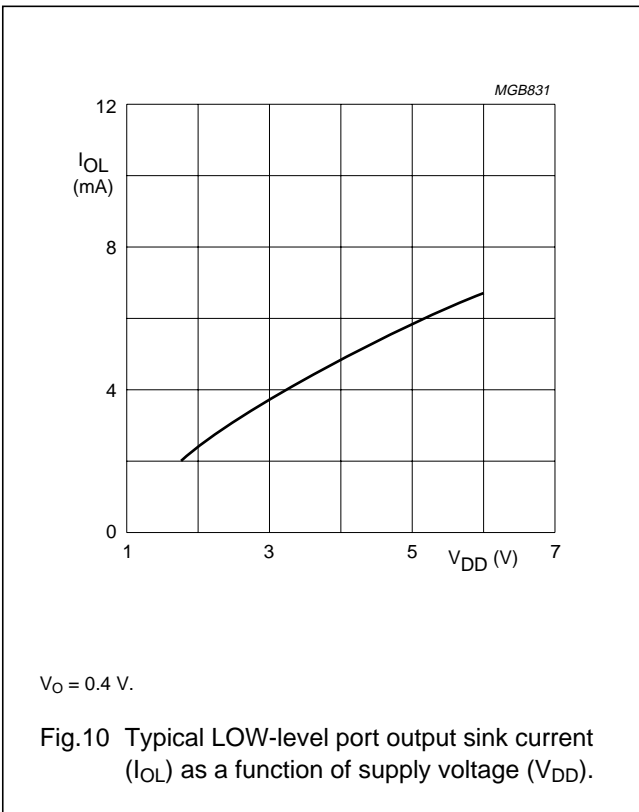
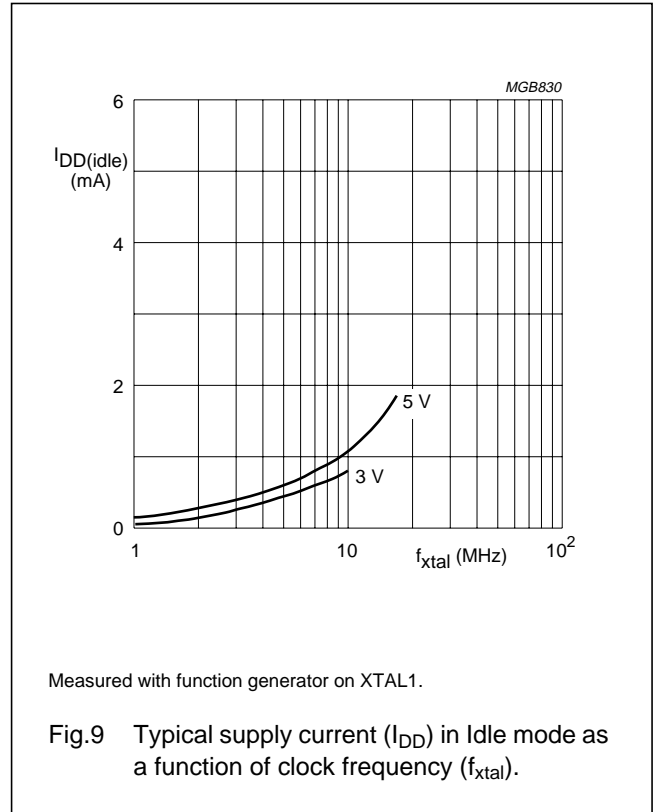
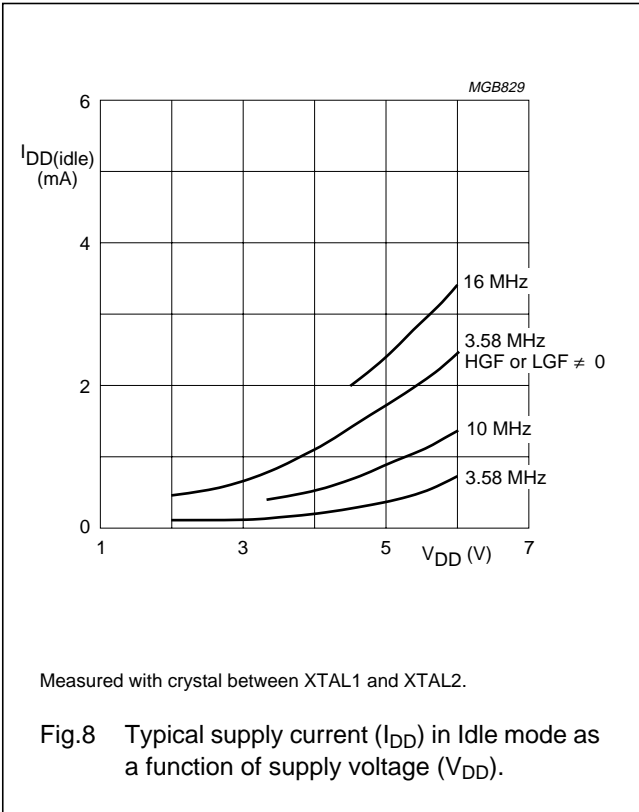

8-bit microcontroller with DTMF generator

PCD3349A

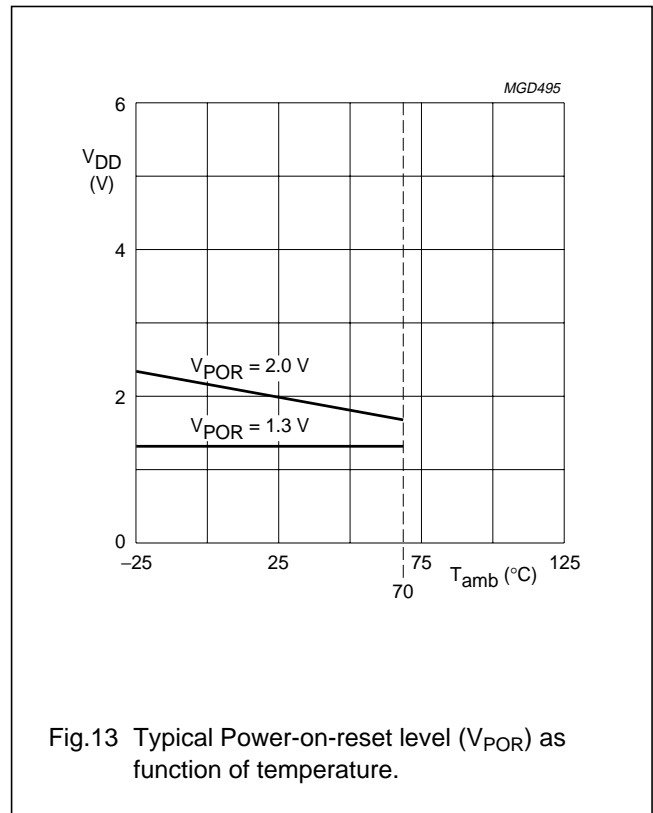
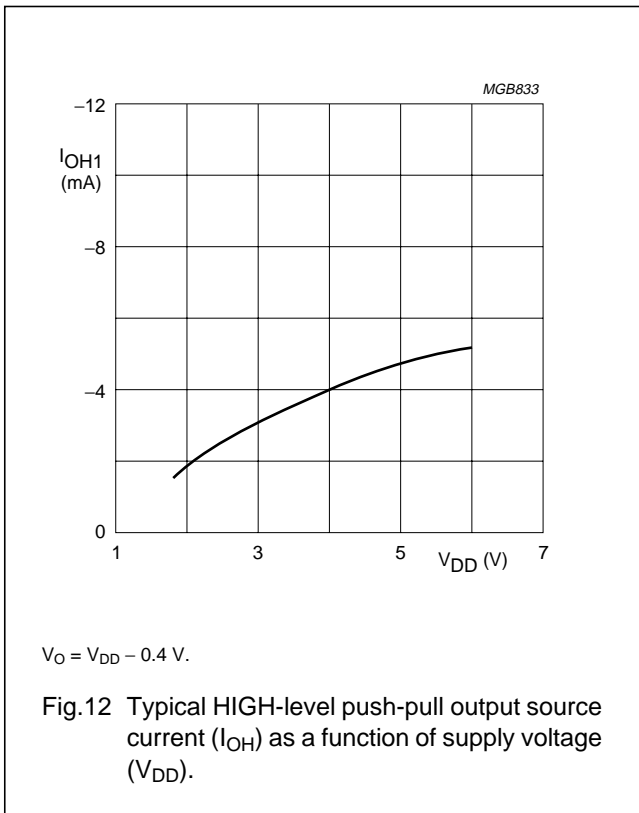

8-bit microcontroller with DTMF generator

PCD3349A

16 AC CHARACTERISTICS

$V_{DD} = 1.8$ to 6 V; $V_{SS} = 0$ V; $T_{amb} = -25$ to $+70$ °C; all voltages with respect to V_{SS} ; unless otherwise specified.

SYMBOL	PARAMETER	CONDITIONS	MIN.	TYP.	MAX.	UNIT
t_r	rise time all outputs	$V_{DD} = 5$ V; $T_{amb} = 25$ °C; $C_L = 50$ pF	–	30	–	ns
t_f	fall time all outputs		–	30	–	ns
f_{xtal}	clock frequency	see Fig.14	1	–	16	MHz
Oscillator (see Fig.15)						
g_{mL}	LOW transconductance	$V_{DD} = 5$ V	0.2	0.4	1.0	mS
g_{mM}	MEDIUM transconductance		0.9	1.6	3.2	mS
g_{mH}	HIGH transconductance		3.0	4.5	9.0	mS
R_F	feedback resistor		0.3	1.0	3.0	MΩ

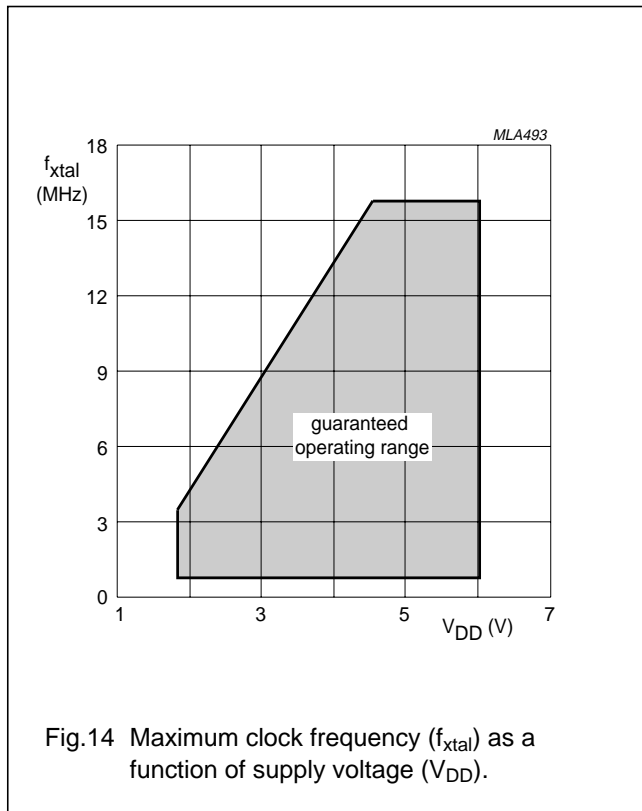

Fig.14 Maximum clock frequency (f_{xtal}) as a function of supply voltage (V_{DD}).

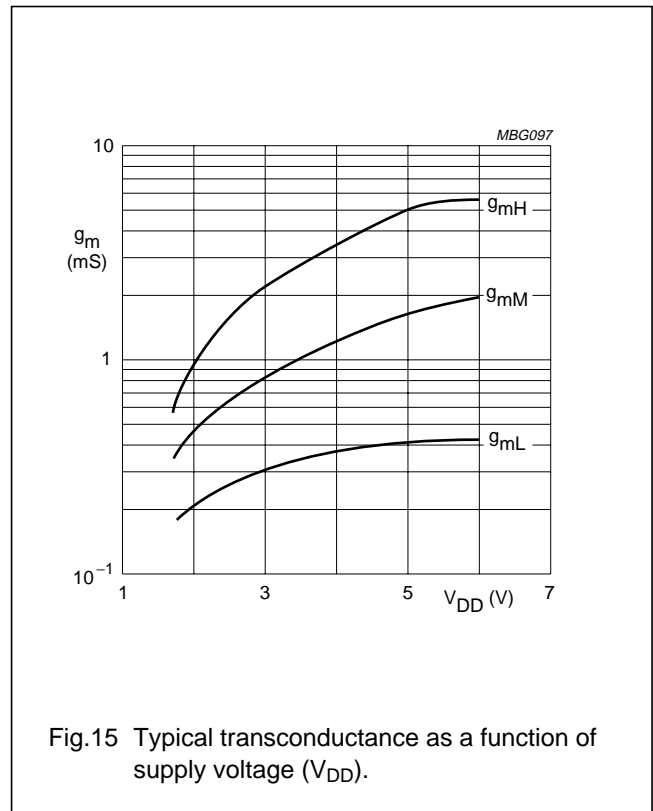

Fig.15 Typical transconductance as a function of supply voltage (V_{DD}).

8-bit microcontroller with DTMF generator

PCD3349A

17 PACKAGE OUTLINES

DIP28: plastic dual in-line package; 28 leads (600 mil)

SOT117-1

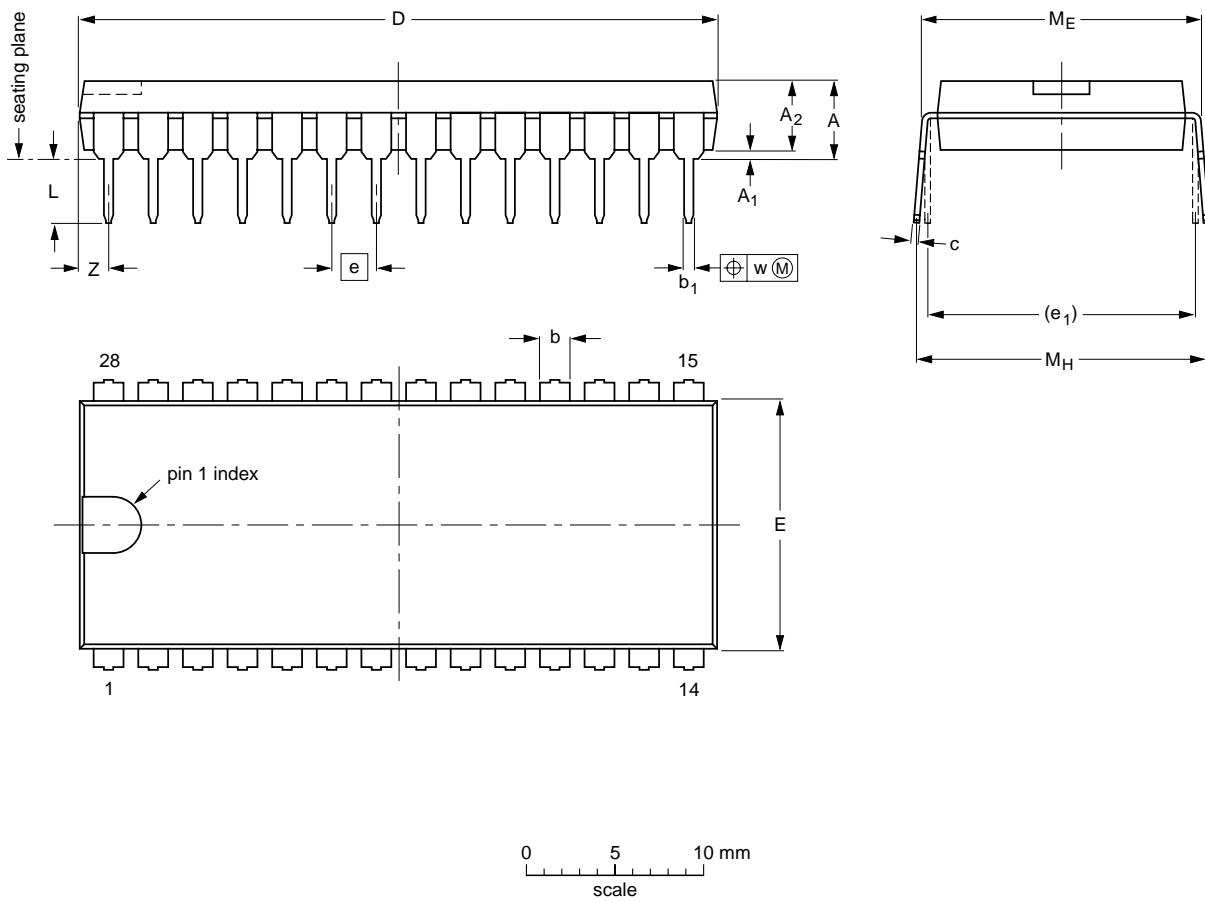

DIMENSIONS (inch dimensions are derived from the original mm dimensions)

UNIT	A max.	A ₁ min.	A ₂ max.	b	b ₁	c	D ⁽¹⁾	E ⁽¹⁾	e	e ₁	L	M _E	M _H	w	Z ⁽¹⁾ max.
mm	5.1	0.51	4.0	1.7 1.3	0.53 0.38	0.32 0.23	36.0 35.0	14.1 13.7	2.54	15.24	3.9 3.4	15.80 15.24	17.15 15.90	0.25	1.7
inches	0.20	0.020	0.16	0.066 0.051	0.020 0.014	0.013 0.009	1.41 1.34	0.56 0.54	0.10	0.60	0.15 0.13	0.62 0.60	0.68 0.63	0.01	0.067

Note

1. Plastic or metal protrusions of 0.25 mm maximum per side are not included.

OUTLINE VERSION	REFERENCES				EUROPEAN PROJECTION	ISSUE DATE
	IEC	JEDEC	EIAJ			
SOT117-1	051G05	MO-015AH				92-11-17 95-01-14

8-bit microcontroller with DTMF generator

PCD3349A

SO28: plastic small outline package; 28 leads; body width 7.5 mm

SOT136-1

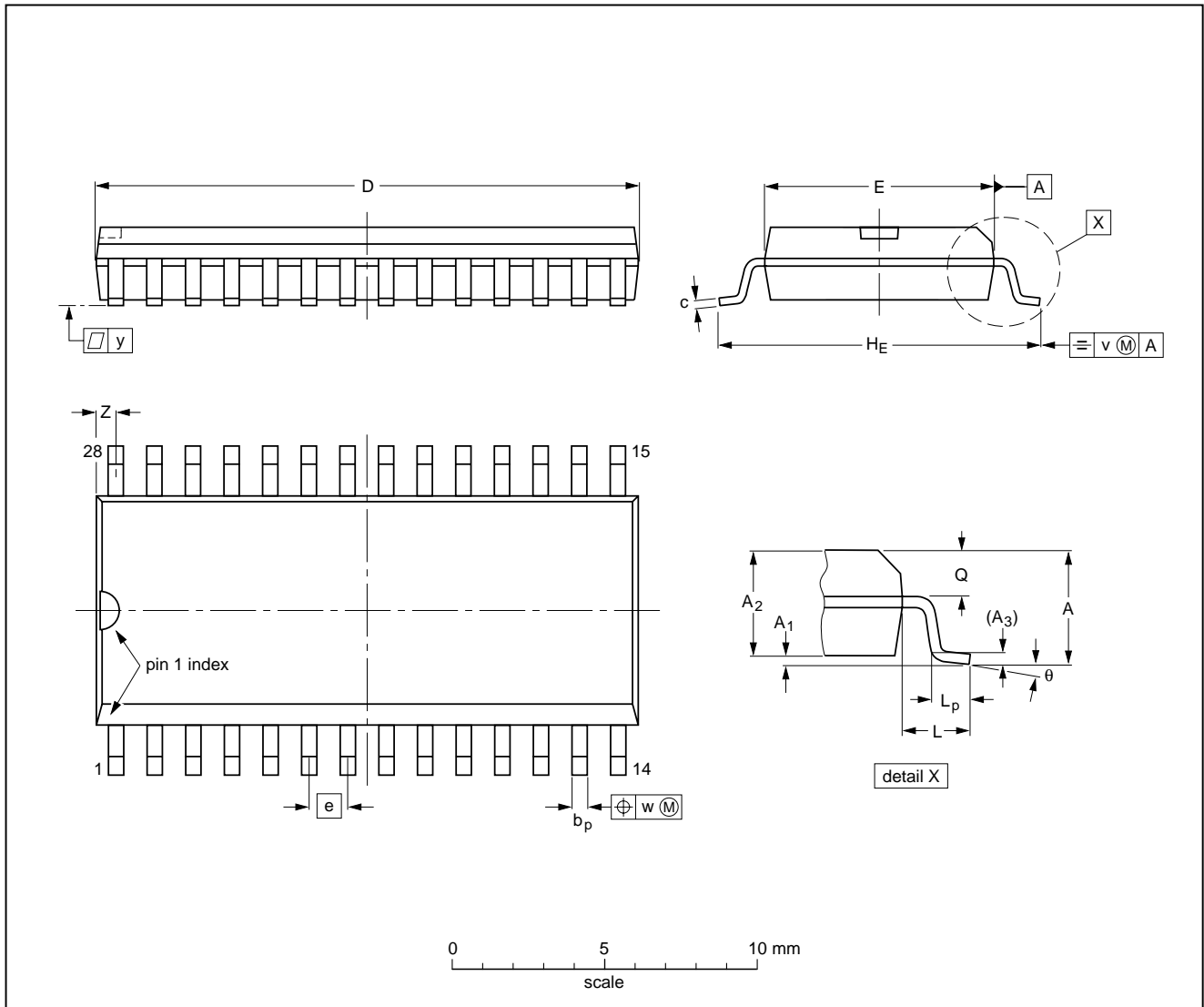

DIMENSIONS (inch dimensions are derived from the original mm dimensions)

UNIT	A max.	A ₁	A ₂	A ₃	b _p	c	D ⁽¹⁾	E ⁽¹⁾	e	H _E	L	L _p	Q	v	w	y	Z ⁽¹⁾	θ
mm	2.65	0.30 0.10	2.45 2.25	0.25	0.49 0.36	0.32 0.23	18.1 17.7	7.6 7.4	1.27	10.65 10.00	1.4	1.1 0.4	1.1 1.0	0.25	0.25	0.1	0.9 0.4	8° 0°
inches	0.10	0.012 0.004	0.096 0.089	0.01	0.019 0.014	0.013 0.009	0.71 0.69	0.30 0.29	0.050	0.419 0.394	0.055	0.043 0.016	0.043 0.039	0.01	0.01	0.004	0.035 0.016	

Note

1. Plastic or metal protrusions of 0.15 mm maximum per side are not included.

OUTLINE VERSION	REFERENCES			EUROPEAN PROJECTION	ISSUE DATE
	IEC	JEDEC	EIAJ		
SOT136-1	075E06	MS-013AE			95-01-24 97-05-22

8-bit microcontroller with DTMF generator

PCD3349A

18 SOLDERING

18.1 Introduction

There is no soldering method that is ideal for all IC packages. Wave soldering is often preferred when through-hole and surface mounted components are mixed on one printed-circuit board. However, wave soldering is not always suitable for surface mounted ICs, or for printed-circuits with high population densities. In these situations reflow soldering is often used.

This text gives a very brief insight to a complex technology. A more in-depth account of soldering ICs can be found in our *"Data Handbook IC26; Integrated Circuit Packages"* (order code 9398 652 90011).

18.2 DIP

18.2.1 SOLDERING BY DIPPING OR BY WAVE

The maximum permissible temperature of the solder is 260 °C; solder at this temperature must not be in contact with the joint for more than 5 seconds. The total contact time of successive solder waves must not exceed 5 seconds.

The device may be mounted up to the seating plane, but the temperature of the plastic body must not exceed the specified maximum storage temperature ($T_{stg\ max}$). If the printed-circuit board has been pre-heated, forced cooling may be necessary immediately after soldering to keep the temperature within the permissible limit.

18.2.2 REPAIRING SOLDERED JOINTS

Apply a low voltage soldering iron (less than 24 V) to the lead(s) of the package, below the seating plane or not more than 2 mm above it. If the temperature of the soldering iron bit is less than 300 °C it may remain in contact for up to 10 seconds. If the bit temperature is between 300 and 400 °C, contact may be up to 5 seconds.

18.3 SO

18.3.1 REFLOW SOLDERING

Reflow soldering techniques are suitable for all SO packages.

Reflow soldering requires solder paste (a suspension of fine solder particles, flux and binding agent) to be applied to the printed-circuit board by screen printing, stencilling or pressure-syringe dispensing before package placement.

Several techniques exist for reflowing; for example, thermal conduction by heated belt. Dwell times vary between 50 and 300 seconds depending on heating method. Typical reflow temperatures range from 215 to 250 °C.

Preheating is necessary to dry the paste and evaporate the binding agent. Preheating duration: 45 minutes at 45 °C.

18.3.2 WAVE SOLDERING

Wave soldering techniques can be used for all SO packages if the following conditions are observed:

- A double-wave (a turbulent wave with high upward pressure followed by a smooth laminar wave) soldering technique should be used.
- The longitudinal axis of the package footprint must be parallel to the solder flow.
- The package footprint must incorporate solder thieves at the downstream end.

During placement and before soldering, the package must be fixed with a droplet of adhesive. The adhesive can be applied by screen printing, pin transfer or syringe dispensing. The package can be soldered after the adhesive is cured.

Maximum permissible solder temperature is 260 °C, and maximum duration of package immersion in solder is 10 seconds, if cooled to less than 150 °C within 6 seconds. Typical dwell time is 4 seconds at 250 °C.

A mildly-activated flux will eliminate the need for removal of corrosive residues in most applications.

18.3.3 REPAIRING SOLDERED JOINTS

Fix the component by first soldering two diagonally-opposite end leads. Use only a low voltage soldering iron (less than 24 V) applied to the flat part of the lead. Contact time must be limited to 10 seconds at up to 300 °C. When using a dedicated tool, all other leads can be soldered in one operation within 2 to 5 seconds between 270 and 320 °C.

8-bit microcontroller with DTMF generator

PCD3349A

19 DEFINITIONS

Data sheet status	
Objective specification	This data sheet contains target or goal specifications for product development.
Preliminary specification	This data sheet contains preliminary data; supplementary data may be published later.
Product specification	This data sheet contains final product specifications.
Limiting values	
Limiting values given are in accordance with the Absolute Maximum Rating System (IEC 134). Stress above one or more of the limiting values may cause permanent damage to the device. These are stress ratings only and operation of the device at these or at any other conditions above those given in the Characteristics sections of the specification is not implied. Exposure to limiting values for extended periods may affect device reliability.	
Application information	
Where application information is given, it is advisory and does not form part of the specification.	

20 LIFE SUPPORT APPLICATIONS

These products are not designed for use in life support appliances, devices, or systems where malfunction of these products can reasonably be expected to result in personal injury. Philips customers using or selling these products for use in such applications do so at their own risk and agree to fully indemnify Philips for any damages resulting from such improper use or sale.

Philips Semiconductors – a worldwide company

Argentina: see South America

Australia: 34 Waterloo Road, NORTH RYDE, NSW 2113, Tel. +61 2 9805 4455, Fax. +61 2 9805 4466

Austria: Computerstr. 6, A-1101 WIEN, P.O. Box 213, Tel. +43 160 1010, Fax. +43 160 101 1210

Belarus: Hotel Minsk Business Center, Bld. 3, r. 1211, Volodarski Str. 6, 220050 MINSK, Tel. +375 172 200 733, Fax. +375 172 200 773

Belgium: see The Netherlands

Brazil: see South America

Bulgaria: Philips Bulgaria Ltd., Energoproject, 15th floor, 51 James Bourchier Blvd., 1407 SOFIA, Tel. +359 2 689 211, Fax. +359 2 689 102

Canada: PHILIPS SEMICONDUCTORS/COMPONENTS, Tel. +1 800 234 7381

China/Hong Kong: 501 Hong Kong Industrial Technology Centre, 72 Tat Chee Avenue, Kowloon Tong, HONG KONG, Tel. +852 2319 7888, Fax. +852 2319 7700

Colombia: see South America

Czech Republic: see Austria

Denmark: Prags Boulevard 80, PB 1919, DK-2300 COPENHAGEN S, Tel. +45 32 88 2636, Fax. +45 31 57 0044

Finland: Sinikalliontie 3, FIN-02630 ESPOO, Tel. +358 9 615800, Fax. +358 9 61580920

France: 51 Rue Carnot, BP317, 92156 SURESNES Cedex, Tel. +33 1 40 99 6161, Fax. +33 1 40 99 6427

Germany: Hammerbrookstraße 69, D-20097 HAMBURG, Tel. +49 40 23 53 60, Fax. +49 40 23 536 300

Greece: No. 15, 25th March Street, GR 17778 TAVROS/ATHENS, Tel. +30 1 4894 339/239, Fax. +30 1 4814 240

Hungary: see Austria

India: Philips INDIA Ltd, Band Box Building, 2nd floor, 254-D, Dr. Annie Besant Road, Worli, MUMBAI 400 025, Tel. +91 22 493 8541, Fax. +91 22 493 0966

Indonesia: PT Philips Development Corporation, Semiconductors Division, Gedung Philips, Jl. Buncit Raya Kav.99-100, JAKARTA 12510, Tel. +62 21 794 0040 ext. 2501, Fax. +62 21 794 0080

Ireland: Newstead, Clonskeagh, DUBLIN 14, Tel. +353 1 7640 000, Fax. +353 1 7640 200

Israel: RAPAC Electronics, 7 Kehilat Saloniki St, PO Box 18053, TEL AVIV 61180, Tel. +972 3 645 0444, Fax. +972 3 649 1007

Italy: PHILIPS SEMICONDUCTORS, Piazza IV Novembre 3, 20124 MILANO, Tel. +39 2 6752 2531, Fax. +39 2 6752 2557

Japan: Philips Bldg 13-37, Kohnan 2-chome, Minato-ku, TOKYO 108-8507, Tel. +81 3 3740 5130, Fax. +81 3 3740 5077

Korea: Philips House, 260-199 Itaewon-dong, Yongsan-ku, SEOUL, Tel. +82 2 709 1412, Fax. +82 2 709 1415

Malaysia: No. 76 Jalan Universiti, 46200 PETALING JAYA, SELANGOR, Tel. +60 3 750 5214, Fax. +60 3 757 4880

Mexico: 5900 Gateway East, Suite 200, EL PASO, TEXAS 79905, Tel. +9-5 800 234 7381

Middle East: see Italy

Netherlands: Postbus 90050, 5600 PB EINDHOVEN, Bldg. VB, Tel. +31 40 27 82785, Fax. +31 40 27 88399

New Zealand: 2 Wagener Place, C.P.O. Box 1041, AUCKLAND, Tel. +64 9 849 4160, Fax. +64 9 849 7811

Norway: Box 1, Manglerud 0612, OSLO, Tel. +47 22 74 8000, Fax. +47 22 74 8341

Pakistan: see Singapore

Philippines: Philips Semiconductors Philippines Inc., 106 Valero St. Salcedo Village, P.O. Box 2108 MCC, MAKATI, Metro MANILA, Tel. +63 2 816 6380, Fax. +63 2 817 3474

Poland: Ul. Lukiska 10, PL 04-123 WARSZAWA, Tel. +48 22 612 2831, Fax. +48 22 612 2327

Portugal: see Spain

Romania: see Italy

Russia: Philips Russia, Ul. Usatcheva 35A, 119048 MOSCOW, Tel. +7 095 755 6918, Fax. +7 095 755 6919

Singapore: Lorong 1, Toa Payoh, SINGAPORE 319762, Tel. +65 350 2538, Fax. +65 251 6500

Slovakia: see Austria

Slovenia: see Italy

South Africa: S.A. PHILIPS Pty Ltd., 195-215 Main Road Martindale, 2092 JOHANNESBURG, P.O. Box 7430 Johannesburg 2000, Tel. +27 11 470 5911, Fax. +27 11 470 5494

South America: Al. Vicente Pinzon, 173, 6th floor, 04547-130 SÃO PAULO, SP, Brazil, Tel. +55 11 821 2333, Fax. +55 11 821 2382

Spain: Balmes 22, 08007 BARCELONA, Tel. +34 93 301 6312, Fax. +34 93 301 4107

Sweden: Kottbygatan 7, Akalla, S-16485 STOCKHOLM, Tel. +46 8 5985 2000, Fax. +46 8 5985 2745

Switzerland: Allmendstrasse 140, CH-8027 ZÜRICH, Tel. +41 1 488 2741 Fax. +41 1 488 3263

Taiwan: Philips Semiconductors, 6F, No. 96, Chien Kuo N. Rd., Sec. 1, TAIPEI, Taiwan Tel. +886 2 2134 2865, Fax. +886 2 2134 2874

Thailand: PHILIPS ELECTRONICS (THAILAND) Ltd., 209/2 Sanpavuth-Bangna Road Prakanong, BANGKOK 10260, Tel. +66 2 745 4090, Fax. +66 2 398 0793

Turkey: Talatpasa Cad. No. 5, 80640 GÜLTEPE/ISTANBUL, Tel. +90 212 279 2770, Fax. +90 212 282 6707

Ukraine: PHILIPS UKRAINE, 4 Patrice Lumumba str., Building B, Floor 7, 252042 KIEV, Tel. +380 44 264 2776, Fax. +380 44 268 0461

United Kingdom: Philips Semiconductors Ltd., 276 Bath Road, Hayes, MIDDLESEX UB3 5BX, Tel. +44 181 730 5000, Fax. +44 181 754 8421

United States: 811 East Arques Avenue, SUNNYVALE, CA 94088-3409, Tel. +1 800 234 7381

Uruguay: see South America

Vietnam: see Singapore

Yugoslavia: PHILIPS, Trg N. Pasica 5/v, 11000 BEOGRAD, Tel. +381 11 625 344, Fax. +381 11 635 777

For all other countries apply to: Philips Semiconductors, International Marketing & Sales Communications, Building BE-p, P.O. Box 218, 5600 MD EINDHOVEN, The Netherlands, Fax. +31 40 27 24825

Internet: <http://www.semiconductors.philips.com>

© Philips Electronics N.V. 1998

SCA60

All rights are reserved. Reproduction in whole or in part is prohibited without the prior written consent of the copyright owner.

The information presented in this document does not form part of any quotation or contract, is believed to be accurate and reliable and may be changed without notice. No liability will be accepted by the publisher for any consequence of its use. Publication thereof does not convey nor imply any license under patent- or other industrial or intellectual property rights.

Printed in The Netherlands

415102/1200/05/pp20

Date of release: 1998 May 11

Document order number: 9397 750 03605

Let's make things better.

**Philips
Semiconductors**



PHILIPS